

accessories

Our *Accessory Items list* will provide your project with the necessary edge trims, mounting and joining clips, straps, posts, and caps to match your specified finishes with maximum flexibility.

Size:

½" leg x 3¼" wide x ½" leg

Materials:

20 gauge galvanized steel

Colors:

- ~ green
- ~ black
- ~ silver
- ~ bronze
- ~ white

Used as a closure strip at edges of **greenscreen®** panels. Recommended on panel edges adjacent to pedestrian traffic or where edge reinforcement for plant maintenance is desired. Not recommended at bottom edge of panel to prevent pooling of water.



5104

Steel Channel Trim

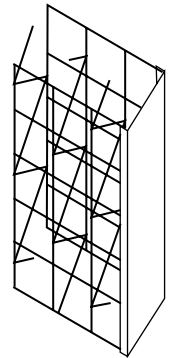

Size:

½" leg x ½" leg

Materials:

20 gauge galvanized steel

Colors:

- ~ green
- ~ black
- ~ silver
- ~ bronze
- ~ white

Used as closure strip at edges of **greenscreen®** panels. Recommended on panel edges adjacent to pedestrian traffic or where edge reinforcement for plant maintenance is desired.



5105

Steel Edge Trim

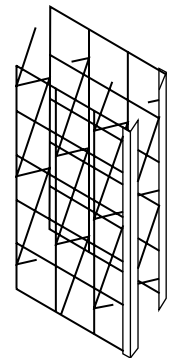

Size:

1½" wide leg x 2" tall x 3" length with 1/2" diameter hole for 3/8" dia. fastener. Adjustable to 4-3/4" length. Two pieces.

Materials:

10 and 14 gauge galvanized steel, powder coated

Colors:

- ~ green
- ~ black
- ~ silver
- ~ bronze
- ~ white

Recommended for use as a flush mounting clip for wall hung or steel mounted **greenscreen**® panels or to support screens off the wall surface, in combination with 5136 Spacer, on uneven or porous surfaces (split face block) or in locations requiring both uplift and down load support.

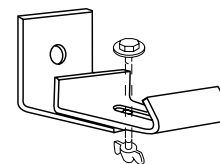
**5132R****Adjustable
Mounting Clip****Size:**

1½" leg x 2" tall x 7½" to 9" length with 1/2" diameter hole for 3/8" dia. fastener. To hold panel from 4-1/2" to 6" from back of panel to mounting surface. Two pieces.

Materials:

10 and 14 gauge galvanized steel, powder coated

Colors:

- ~ green
- ~ black
- ~ silver
- ~ bronze
- ~ white

Gusseted Clip, recommended for use as a mounting clip for wall hung or steel mounted **greenscreen**® panels or to support screens off the wall surface, in combination with 5136 Spacer, on uneven or porous surfaces (split face block) or in locations requiring both uplift and down load support.

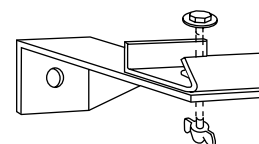
**5132G****Adjustable
Mounting Clip**

Size:

1½" wide x 6¼" tall x up to 18".
Specify length to hold screen from 6" to 15" from back of panel to mounting surface.
With two 1/2" diameter holes use with 3/8" dia. fastener.
1-½" adjustable.
Two pieces.

Materials:

10 and 14 gauge galvanized steel, powder coated

Colors:

- ~ green
- ~ black
- ~ silver
- ~ bronze
- ~ white

Recommended for use as a mounting bracket for wall hung **greenscreen®** panels to support screens held off the wall surface a maximum of 18". May be used in combination with (2) 5136 Spacers on uneven or porous surfaces requiring both uplift and down load support.



5159

Standoff Bracket

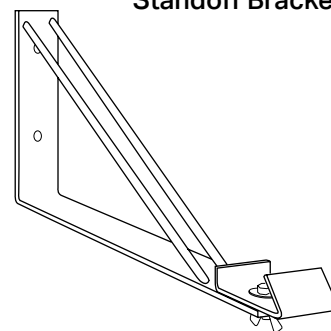

Size:

½" leg x 3¼" x ½" leg x 1¾" wide with 1/2" diameter hole for use with 3/8" dia. fastener.

Materials:

14 gauge galvanized steel, powder coated

Colors:

- ~ green
- ~ black
- ~ silver
- ~ bronze
- ~ white

Used on panels with Channel or Edge Trim to hold screen edge to a vertical wall, column or post, or to attach screen bottom edge to a horizontal slab or beam, or used as a pair to join curved screens at a horizontal joint. Commonly used with #5142 + 5136 spacers.

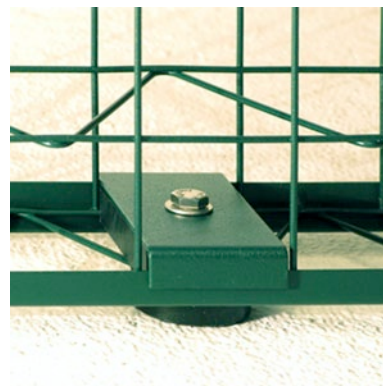
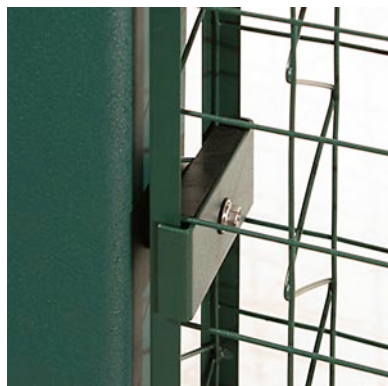

5141

"C" Clip

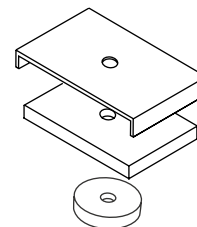

Size:

1 3/4" wide x 5" x 3" with slotted 5/16" dia. hole for use with 1/4" dia. fasteners.

Materials:

10 gauge galvanized steel

Colors:

- ~ green
- ~ black
- ~ silver
- ~ bronze
- ~ white

Used for mounting panels in freestanding flush applications. Snaps onto top, bottom or sides of panels (with no trim) and in the field is screwed to structural supports with self tapping fasteners. Requires access to one side of panel only for installation.



5133X

Snap Clip

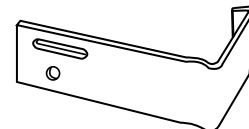
**Size:**

3" wide x 48" long x 1/8" thick with (6) holes for 3/8" dia. fasteners.

With Stainless Steel bolt, nut and washers.

Materials:

10 gauge galvanized steel

Colors:

- ~ green
- ~ black
- ~ silver
- ~ bronze
- ~ white

For mounting standard **greenscreen®** panels on 4' Fiberglass Planter or custom designed planters.

5135

Planter Straps

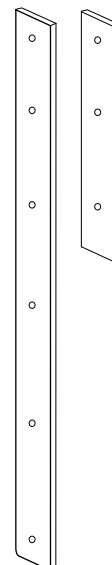

Steel Posts: Used for freestanding modular screens and fences. Available square or round in 1" incremental lengths.

Size:
3" square or 3" diameter round and up to 16' maximum length

Materials: Steel
Square: ASTM A-500B 3/16" thick
Round: ASTM A-1101 .111" thick
(Nominal 2-7/8" Dia.)

Colors:

- ~ green
- ~ black
- ~ silver
- ~ bronze
- ~ white

Post Caps: Available to fit round or square posts.

Size:
Round cap: 3½" diameter o.d.
Square: 3¼" x 3¼"

Materials:
Round cap is die cast steel.
Square is stamped steel.

Colors:

- ~ green
- ~ black
- ~ silver
- ~ bronze
- ~ white

**Steel Posts
Post Caps**

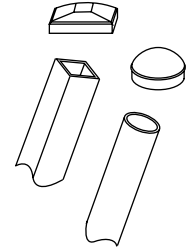

5136/5136.25 Round Spacer: Used for spacing mounting clips away from porous mounting surface.

Size:
½" or ¼" thick x 1½" diameter.
With 7/16" hole.

Materials:
UHMW High density,
Recycled non UV degradable plastic

Color: black

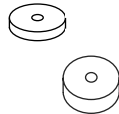

5142 Spacer: Used for spacing mounting clips away from wall or floor surface.

Size:
½" thick x 2⅝" x 1¾" with 7/16" hole

Materials:
UHMW High density,
Recycled non UV degradable plastic

Color: black

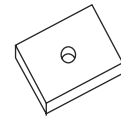

5131 Flex "C" Ring: Used for "in-field" aligning greenscreen® panels edge to edge (without trim.)

Size:
Approximately 5/16" diameter

Materials:
16 gauge galvanized steel

Color: galvanized

